

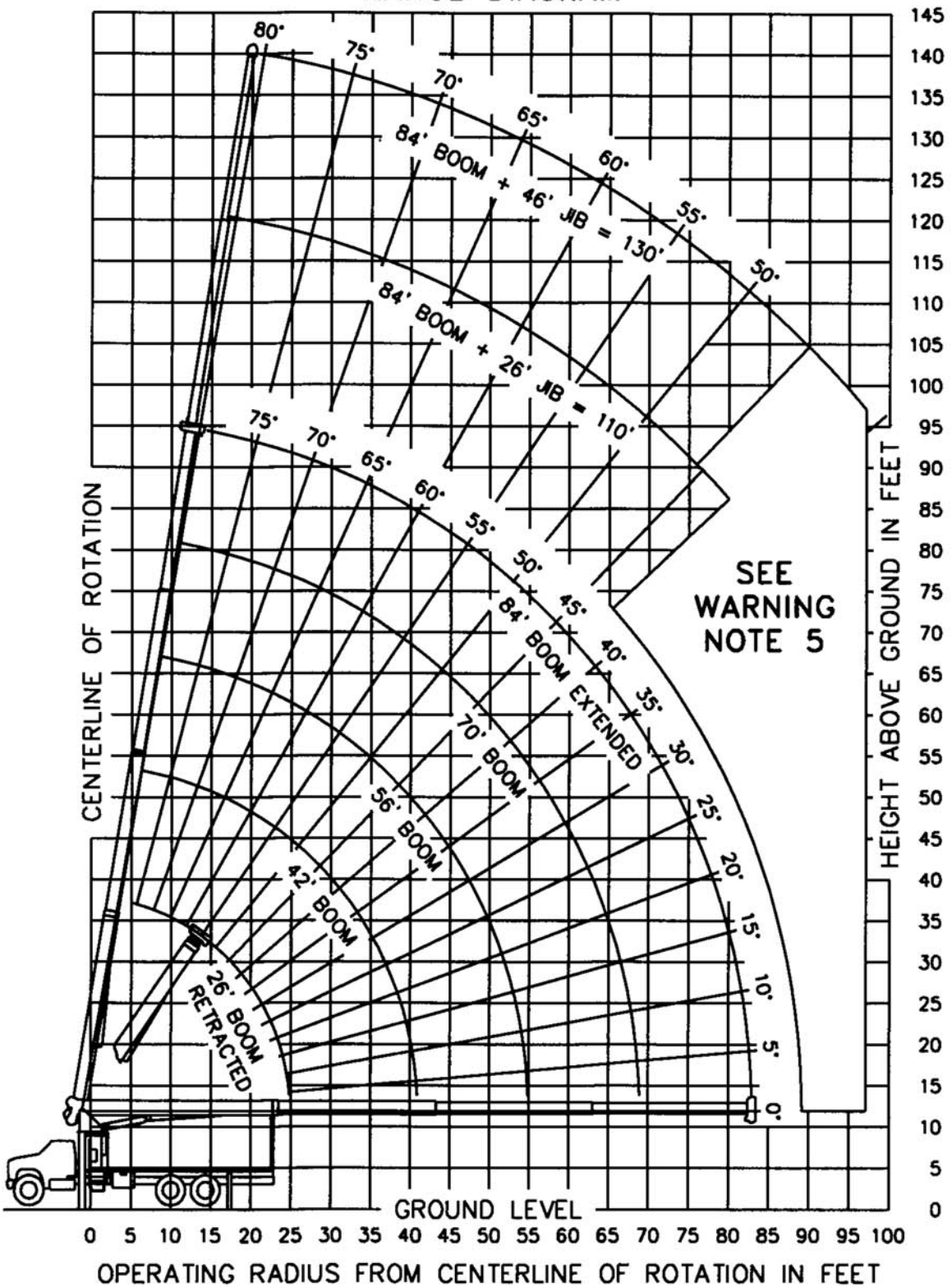

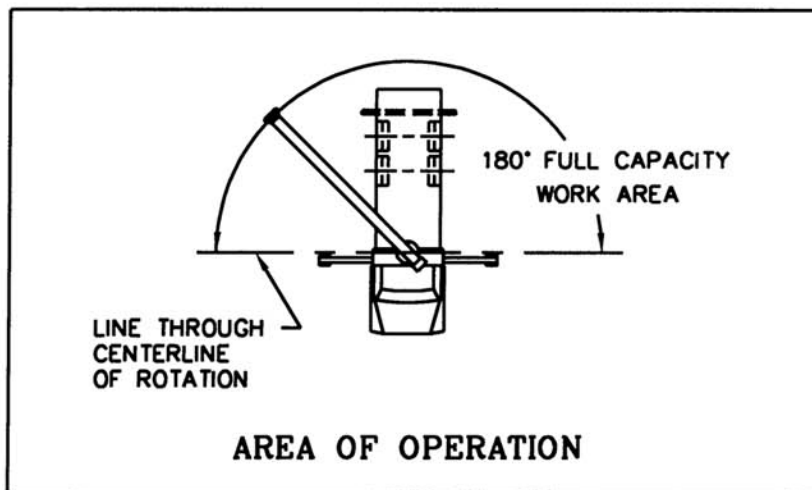



RANGE DIAGRAM

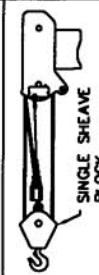

LOAD RATINGS IN LBS WITH OUTRIGGERS AND STABILIZERS EXTENDED										
OPERATING HEIGHT	LOADED BOOM ANGLE		BOOM LENGTH							
	26 FT	42 FT	56 FT	70 FT	84 FT					
4	80	44000								
6	77	34600								
8	72	27800								
10	67	23350	77	20000						
12	62	20200	74	17860	79	16400				
14	57	17780	71	15660	76	14400	80	13320		
16	51	15870	68	13930	74	12780	78	11770		
20	38	12800	62	11400	70	10400	75	9570	78	8900
25			54	9230	64	8400	70	7710	74	7180
30			44	7630	58	7000	66	6410	71	5910
35			33	6260	52	5910	61	5410	67	4980
40			14	4500	45	5040	56	4630	63	4260
45					37	4260	51	4000	59	3670
50					26	3470	45	3460	55	3190
55							39	2960	51	2770
60							31	2430	46	2390
65							21	1920	41	2010
70									35	1620
75									27	1300
80									19	990
		650 LBS.	400 LBS.	300 LBS.	250 LBS.	200 LBS.	DEDUCTIONS FOR STOWED JIB			

JIB LOAD RATINGS WITH OUTRIGGERS AND STABILIZERS EXTENDED						
OPERATING HEIGHT	26 FT JIB FOR ALL BOOM LENGTHS SEE WARNING NOTE 4			46 FT JIB FOR ALL BOOM LENGTHS SEE WARNING NOTE 4		
	25	30	35	40	45	50
25	79	4510	25			
30	76	3890	30	79	3100	
35	74	3350	35	77	2800	
40	71	2900	40	75	2520	
45	68	2500	45	72	2240	
50	65	2170	50	70	1980	
55	62	1870	55	67	1750	
60	59	1520	60	65	1550	
65	56	1240	65	63	1370	
70	52	980	70	60	1210	
75	49	760	75	57	1050	
80	45	570	80	54	850	
85			85	51	680	
90			90	48	520	
95			95			
100			100			



ALLOWABLE LINE PULL						WARNING
1 PART LINE	2 PART LINE	3 PART LINE	4 PART LINE	5 PART LINE	6 PART LINE	
						<p>ANTI-TWO-BLOCK SYSTEM MUST BE IN GOOD OPERATING CONDITION BEFORE OPERATING CRANE. REFER TO OWNER'S MANUAL.</p> <p>KEEP AT LEAST 3 WRAPS OF LOAD LINE ON DRUM AT ALL TIMES.</p>
8500 LBS	17000 LBS	25500 LBS	34000 LBS	42500 LBS	44000 LBS	<p>9/16" - 6X25 IWRC (3.5:1 S.F.) 29750 LBS. BREAKING STRENGTH</p> <p>9/16" ROT RESISTANT (5.0:1 S.F.) 37000 LBS. BREAKING STRENGTH</p>
7400 LBS	14800 LBS	22200 LBS	29600 LBS	37000 LBS	44000 LBS	

DEDUCTIONS FROM RATED LOADS FOR MANITEX SUPPLIED LOAD HANDLING DEVICES	
AUXILIARY BLOCK	50 LBS
OVERHAUL BALL	120 LBS
SINGLE SHEAVE LOAD BLOCK	260 LBS
DOUBLE SHEAVE LOAD BLOCK	350 LBS
TRIPLE SHEAVE LOAD BLOCK	380 LBS
HOSE REEL	140 LBS
SWING AROUND JIB (STOWED)	SEE LOAD CHART

WARNING
LIFTING OFF THE MAIN BOOM POINT WHILE THE SWING AROUND JIB IS ERECTED IS NOT INTENDED OR APPROVED.

WARNING

1. THE OPERATOR MUST READ AND UNDERSTAND THE OWNER'S MANUAL BEFORE OPERATING THIS CRANE.
2. POSITIONING OR OPERATION OF CRANE BEYOND AREAS SHOWN ON THIS CHART IS NOT INTENDED OR APPROVED EXCEPT WHERE SPECIFIED IN OWNER'S MANUAL.
3. LOADED BOOM ANGLES AT SPECIFIED BOOM LENGTHS GIVE ONLY AN APPROXIMATION OF THE OPERATING RADIUS. THE BOOM ANGLE BEFORE LOADING SHOULD BE GREATER TO ACCOUNT FOR DEFLECTIONS. DO NOT EXCEED THE OPERATING RADIUS FOR RATED LOADS.
4. THE OPERATING RADIUS SHOWN IN THE JIB RATING CHART IS FOR FULLY EXTENDED BOOM ONLY. WHEN BOOM IS NOT FULLY EXTENDED, USE ONLY LOADED BOOM ANGLE TO DETERMINE LOAD RATING OF JIB. DO NOT RELY ON CAPACITY ALERT SYSTEM WHEN LIFTING FROM JIB.
5. BOOM MUST BE FULLY RETRACTED WHEN JIB IS ERECTED, BEFORE LOWERING BOOM THRU THIS AREA.
6. FOR BOOM ANGLES NOT SHOWN ON JIB LOAD RATING CHART, USE RATING OF NEXT LOWER BOOM ANGLE.
7. FOR BOOM LENGTHS NOT SHOWN, USE RATING OF THE NEXT LONGER BOOM. FOR RADII NOT SHOWN, USE RATING OF NEXT LONGER RADIUS.
8. CRANE LOAD RATINGS ON OUTRIGGERS ARE BASED ON FREELY SUSPENDED LOADS WITH THE MACHINE LEVELED AND STANDING ON A FIRM UNIFORM SUPPORTING SURFACE. NO ATTEMPT SHALL BE MADE TO MOVE A LOAD HORIZONTALLY ON THE GROUND IN ANY DIRECTION.
9. PRACTICAL WORKING LOADS DEPEND ON SUPPORTING SURFACE, WIND, AND OTHER FACTORS AFFECTING STABILITY SUCH AS HAZARDOUS SURROUNDINGS, EXPERIENCE OF PERSONNEL, AND PROPER HANDLING, ALL OF WHICH MUST BE TAKEN INTO ACCOUNT BY THE OPERATOR.
10. THE MAXIMUM LOAD WHICH MAY BE TELESCOPED IS LIMITED BY HYDRAULIC PRESSURE, BOOM ANGLE, AND BOOM LUBRICATION. IT IS SAFE TO ATTEMPT TO TELESCOPE ANY LOAD WITHIN THE LIMITS OF THE LOAD RATING CHART.

INFORMATION

1. DEDUCTIONS MUST BE MADE FROM RATED LOADS FOR STOWED JIB, OPTIONAL ATTACHMENTS, HOOKS, AND LOAD-BLOCKS (SEE DEDUCTION CHART). WEIGHTS OF SLINGS AND ALL OTHER LOAD HANDLING DEVICES SHALL BE CONSIDERED A PART OF THE LOAD.
2. CRANE LOAD RATINGS WITH OUTRIGGERS ARE BASED ON OUTRIGGERS AND STABILIZERS EXTENDED AND SET WITH MACHINE LEVELED.
3. MAIN BOOM LOAD RATINGS ABOVE THE HEAVY LINE ARE BASED ON CONSTANT HOIST CYLINDER PRESSURE, MACHINE STRUCTURAL COMPETENCE, AND DO NOT EXCEED 85% OF TIPPING. JIB LOAD RATINGS ABOVE THE HEAVY LINE ARE BASED ONLY ON MACHINE STRUCTURAL COMPETENCE AND DO NOT EXCEED 85% OF TIPPING.

DEFINITIONS

1. OPERATING RADIUS IS THE HORIZONTAL DISTANCE FROM THE AXIS OF ROTATION TO THE CENTER OF THE VERTICAL HOIST LINE OR TACKLE WITH LOAD APPLIED.
2. LOADED BOOM ANGLE AS SHOWN IN THE COLUMN HEADED BY \angle , IS THE INCLUDED ANGLE BETWEEN THE HORIZONTAL AND LONGITUDINAL AXES OF THE BOOM BASE AFTER LIFTING RATED LOAD AT RATED RADIUS.

DESCRIPTION DU VEHICULE

CAMION A FLECHE
GRUE: MANITEX 2284
CAMION: FORD LTS-9000
AVEC PLATE-FORME ET FLECHE
VERS L'ARRIERE

ACCESSOIRES DE LEVAGE

Manille ——— (Shackle)
Etrangleur ——— (Choker)
Elingue ——— (Spreader)

1—Manilles 17 Tonnes
2—Manilles 9 1/2 Tonnes
4—Manilles 4 3/4 Tonnes
4—Etrangleurs 5/8" x 8' ou 10'
4—Elingues 5/8" x 15'
1—Crochet 2 Poulies
1—Crochet 1 Poulie
1—Poulie Auxiliaire
1—Boule

Divers: Support de Flèche

LES ACCESSOIRES DE LEVAGE
SONT PLACES DANS LE COFFRE
DU VEHICULE

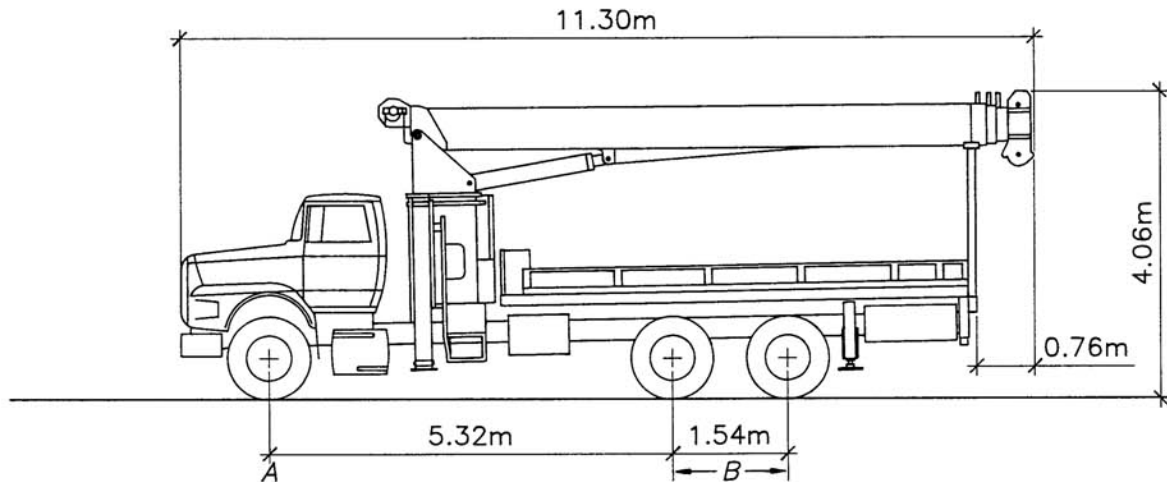
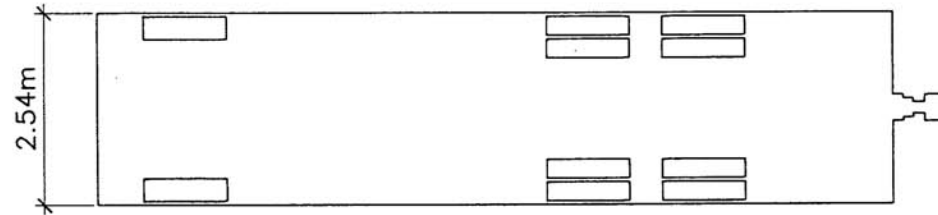

M.T.C. PERMISE EN PERIODE NORMALE: répartition A= 5500 Kg

B= 18000 Kg

total 23500 Kg

M.T.C. PERMISE EN PERIODE DE DEGEL: répartition A= 5500 Kg

B= 15000 Kg

total 20500 Kg

PNEUS: avant 315/80R22.5 arrière 12R22.5

P.N.B.E.: avant 7257 Ka arrière 9071 Ka